

SOUTHBOUND MOTOR TRIMMERS

FULL PRICELIST FOR 2022

Updated: December 2022

If you've had to buy Porsche materials or fittings to make a repair to the trim of your car, you'll be aware of how expensive they are.

We have a range of Original Equipment (O.E.) German materials available:

- The correct carpet by the metre or as ready to fit sets, from 356 right through to current models including salt and pepper as fitted to early 1970's cars.
- Many original cloths including Pinstripe, Logo etc as used during the 1980's.
- Leather, most of the current colour range is available in full or half hides.
- Vinyl for panels and seats.
- Targa outer roof and headliner materials (also ready made covers).
- Mohair hooding for cabriolet models by the metre or supplied ready made. We can also supply new, clear, flexible rear window glass.
- Hood fittings, Tenax studs and buttons (German) black finish.
- Door panel clips, door fittings, Targa roof fittings, seat hex cap bolts and many other accessories (all of the above is sourced from Germany and are the correct fittings or a compatible equivalent).

All materials and fittings represent a significant saving over Porsche prices [without sacrificing quality or attention to detail.](#)

ALL PRICES ARE SUBJECT TO ALTERATION
ALL PRICES PLUS VAT UNLESS MARKED "inc"
VISA/MASTERCARD ACCEPTED

LIST OF CONTENTS

Seats & seat cover parts
 Page 3 to 8
 Recaro shell & RS 964 / 993 seat trim
 options page 9

Interior Panels

911 Page 9 to 11
 RS Page 12 / 13

Trim General

911/964/993 Page 14 to 16
 924/944/968 Page 17
 928 Page 17
 Boxster 986/911 996 Page 18
 356 ABC Page 19

Carpets sets & Floor mats Page 19/20
Individual Carpet parts page 21 to 23

Hoods and Headliners Page 24/25
Targa Roof Pricing/parts page 26/27

Fittings page 28

Materials page 29/30

Original Materials and Codes

Leather Page 31
 Fabric / vinyls / carpets page 32 to 34

356A 1950 – 1959

356 B&C 1960 - 1965

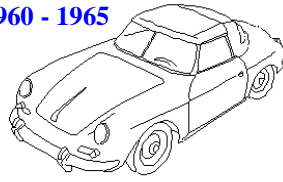

914 1970 – 1976

924 1976 – 1985

924S 1986 - 1988

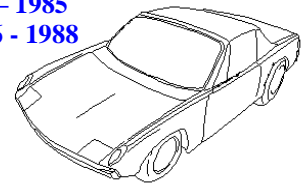

911 Targa 1965 - 1973

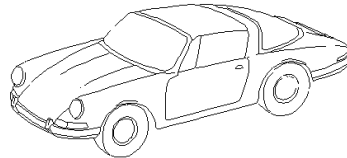

911 Carrera 1974 - 1979

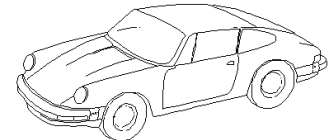

911 Carrera Turbo 1985 - 1989



928 1978 - 1995



944 1982 - 1991

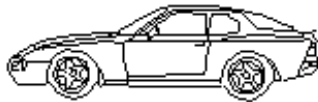

911 Cabrio 1985 -



959 1987 - 1988



911 Carrera 1994 - 1998

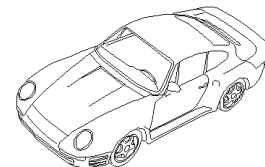

968 1992 - 1995

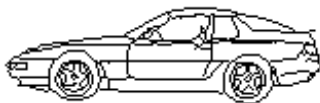

968 Cabrio 1992 - 1995



986 Boxster 1997 -

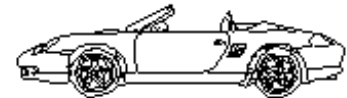

993 Carrera RS 1994 - 1995



GT3 1999 -



Cayenne 2003 -



SEAT TYPES (YEARS & MODELS)

1

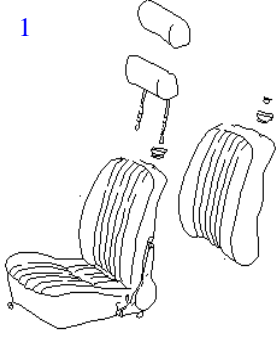

Standard basic seat, 356, 912, 911 up to 1974

2

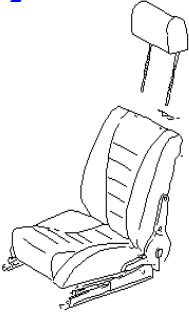

RS Touring sports seat up to 1974

3

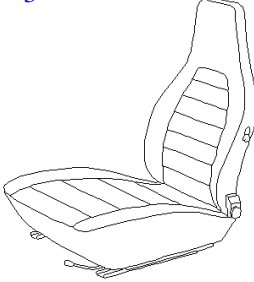

Standard 911 seat 1974 to 1977 and 924 seat up to 1987

4

911 Sports Seat



1974 to 1980

5

911 Standard Seat 1977 to 1983, Splayed type design

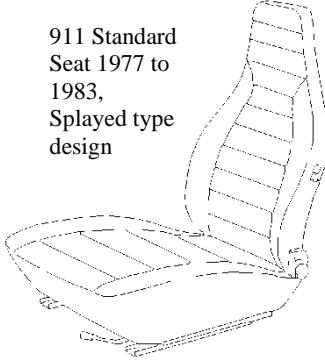

6

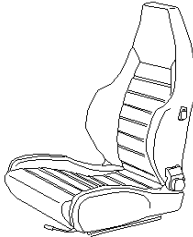

911 Sports Seat 1980 – 1983, 924 Sports & specials up to 1987

7 Available with electric adjustment



928 1978 to 1983

8 Available standard & sports

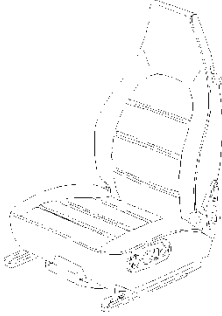

928 1983 to 1995

9

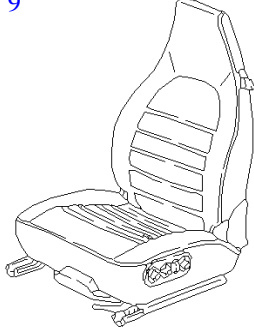

911/944 Standard electric 1984 to 1993

10

911/944 Sports electric 1984 to 1993



11 964/968/993 RS Lightweight

Shell bucket 1992 to 1998

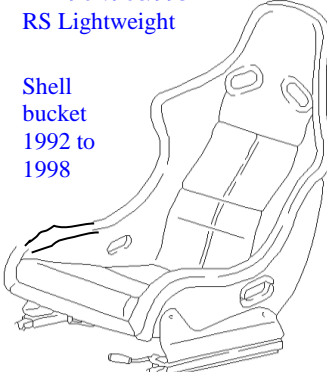

12

993/968 From 1994

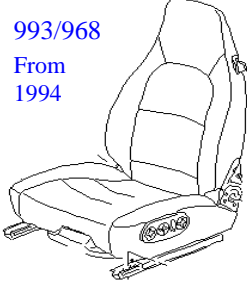

Standard electric seat. Available in Sports electric

SEATS

13
Sport shell backed electric
1994 to 1998
993

14
Standard electric seat
Boxster/ 996
1997 to 2005

15
Sports electric seat
Boxster/ 996
1998 to 2005

REAR SEATS

16
GT3 Type shell bucket seat from 1997

Rear seat and backrest 356/ 912/911 until 1976

Rear seat and backrest 996 1988 to 2005

Rear seat and backrest 993 1994 to 1998.

Seating skirt 911 1964 to 1966

Rear seat and backrest 911 1977 to 1993

944/968 Rear seat and folding backrest until 1994 – 1995

Rear seat and backrest 924 up to 1988, 944 up to 1992

Cayenne Rear Seating

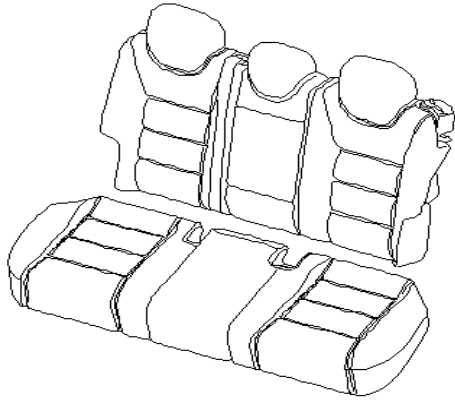

928 Rear seating and backrests

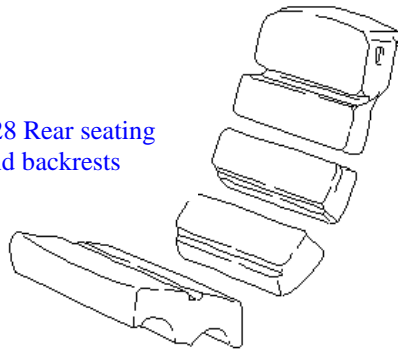

Rear seat pad,
968 1994 to
1995

SEATS

RETRIM

	Front seats retrimmed in OE leather Per Pair (Ruched see item 10 below)	Front & rear seats retrimmed in OE leather	Front seats retrimmed in OE Vinyl/cloth Per Pair	Front & rear seats retrimmed in OE Vinyl/cloth	Front seats (centre sections) retrimmed in OE cloth	Front seat new leather facings OE Per Pair	Front seats new cloth and vinyl facings OE Per Pair	Front seats retrimmed in half leather/vinyl OE Per Pair
356ABC *	£1,624.35	£2,245.95	£1,512.00	£2,110.50	£1,034.25	£1,320.90	£1,202.25	£1,586.55
912 / 911 to 73	£1,624.35	£2,245.95	£1,512.00	£2,110.50	£1,034.25	£1,320.90	£1,202.25	£1,586.55
911 74 to 83	£1,795.50	£2,310.00	£1,643.25	£2,248.05	£1,082.55	£1,424.85	£1,253.70	£1,765.05
911 83 to 94	£1,795.50	£2,310.00	£1,643.25	£2,248.05	£1,082.55	£1,424.85	£1,253.70	£1,765.05
993 / 94 to 98 *	£1,795.50	£2,310.00	£1,643.25	£2,248.05	£1,082.55	£1,424.85	£1,253.70	£1,765.05
924 / 944 / 968 *	£1,795.50	£3,090.15	£1,643.25	£2,717.40	£1,082.55	£1,424.85	£1,253.70	£1,765.05
928 (see item 2)	£2,536.80	£3,845.10	£2,472.75	£3,712.80	£1,729.35	£1,958.25	£1,811.25	£2,279.55
Boxster/996/997	£1,781.85	£2,420.25						

SUPPLY ONLY

	Front seat covers OE leather Perf £88 extra Pair Headrest covers £10.00 each	Front and rear seat covers OE leather Perf extra	Front seat covers OE cloth/ vinyl Pair	Front & rear seat covers OE Vinyl/cloth Headrest covers £10.00 each	Front seats centre sections Leather OE Perf/ cloth, each	Front seat covers half OE leather/vinyl Pair
356ABC	£1,156.20	£1,517.00	£1,037.30	£1,387.85	£100.45	£1,093.68
912	£1,156.20	£1,517.00	£1,037.30	£1,387.85	£100.45	£1,093.68
911 to 73	£1,156.20	£1,517.00	£1,037.30	£1,387.85	£100.45	£1,093.68
911 74 to 94	£1,234.10	£1,691.25	£1,100.85	£1,543.65	£105.58	£1,174.65
993 94 to 98	£1,234.10	£1,691.25	£1,100.85	£1,543.65	£110.70	£1,174.65
924 / 944 / 968	£1,234.10	£2,236.55	£1,100.85	£2,102.28	£105.58	£1,174.65
928 (see item 2)	£1,727.13	£2,594.28	£1,404.25	£2,142.25		
Boxster/996/ 997	£1,340.70	£1,947.50				

* Needs exchange cover parts.

- | | | | |
|----|---|-----------------------|--|
| 1 | Perforated leather original spec. | £92.40 | extra per pair of seats. |
| 2 | 928 Electric early type Pre 1984. | £436.80 | extra per pair of front seats. |
| 3 | 993/996 Sports Carbon backed type: | Add | £121.80 for extra time involved per pair front seats |
| 4 | Replace piping only | From | £501.90 per seat. |
| 5 | Head rest frame & foam, untrimmed | £145.95 | B |
| 6 | Seat frame, base, early RS c 1973 | £499.80 | RS Touring part produced in house |
| 7 | Seat frame, back, early RS c 1973 | £499.80 | RS Touring part produced in house |
| 8 | Seats with heating, reuse existing elements 3.2 / 964 / 993 | £92.40 | extra per pair . |
| 9 | New cables, sports seat '74 - '80 | £38.85 | each, short and long |
| 10 | Ruched effect 3.2/964/993/ 928/996 | £313.95 | pair add extra to seat pricing |
| 11 | Special order leather colours | + £304.5 or + £622.65 | on pair of seats one off colour. (no discount) |
| 12 | Rear seats back rest 993 supply centre part surcharge. | £367.50 | pair |

Rear seats 911 up to 1993 Single cover parts

- | | | | |
|----|-------------------------------|-----|------|
| 1. | Seat pad cover in cloth | £85 | Each |
| 2. | Seat pad cover in vinyl | £67 | Each |
| 3. | Seat pad cover in leather | £88 | Each |
| 4. | Back rest middle part cloth | £83 | Each |
| 5. | Back rest middle part vinyl | £67 | Each |
| 6. | Back rest middle part leather | £91 | Each |
| 7. | Back rest wing parts cloth | £29 | Each |
| 8. | Back rest wing parts vinyl | £29 | Each |
| 9. | Backrest wing parts leather | £39 | Each |

seats : 356 A , B , C / 911 / 912 upto 1973

- | | | | |
|-----|---|---------|---------------------------------|
| 1. | Retrim seat complete in vinyl / cloth From | £751.80 | per seat (Plus parts see below) |
| | Retrim seat complete in leather from | £822.15 | per seat (Plus parts see below) |
| 2. | Backrest refurb parts rubber support rings each | £2.05 | |
| | Hessian pad each | £29.73 | |
| 3. | Foam pad back support each | £114.80 | |
| 4. | Backrest cover supply,vinyl / cloth each from | £279.83 | |
| | Leather from | £338.25 | |
| 5. | Metal pan base shot blast / powder coat black each | £46.13 | |
| 6. | Seat spring base unit each | £156.83 | |
| 7. | Seat base foam each | £112.00 | |
| 8. | Seat base cover supply vinyl / cloth each | £234.73 | |
| | Leather from | £282.90 | |
| | Option : per seat , remove all trim / covers , replace rubber support rings , | £295.20 | plus parts. |
| 9. | replace hessian pad ,repad / reuse existing padding , labour | | |
| 10. | Hessian for seat base each | £7.18 | |
| 11. | Recliners / hinges as parts No 16 black type recon each | £76.88 | |
| | As above but chrome type rechrome etc each | £133.25 | |
| 12. | Headrest, flat base type recon metal plate to OE finish each | £24.60 | |
| 13. | Seat shield plastic see no. 26 in figure below | £57.40 | each |

All prices + vat

Model	Year	MG	SG	Illustration	Restrictions	Update	10:46	06.10.2011
911	68	8	08	808-05	-	165		

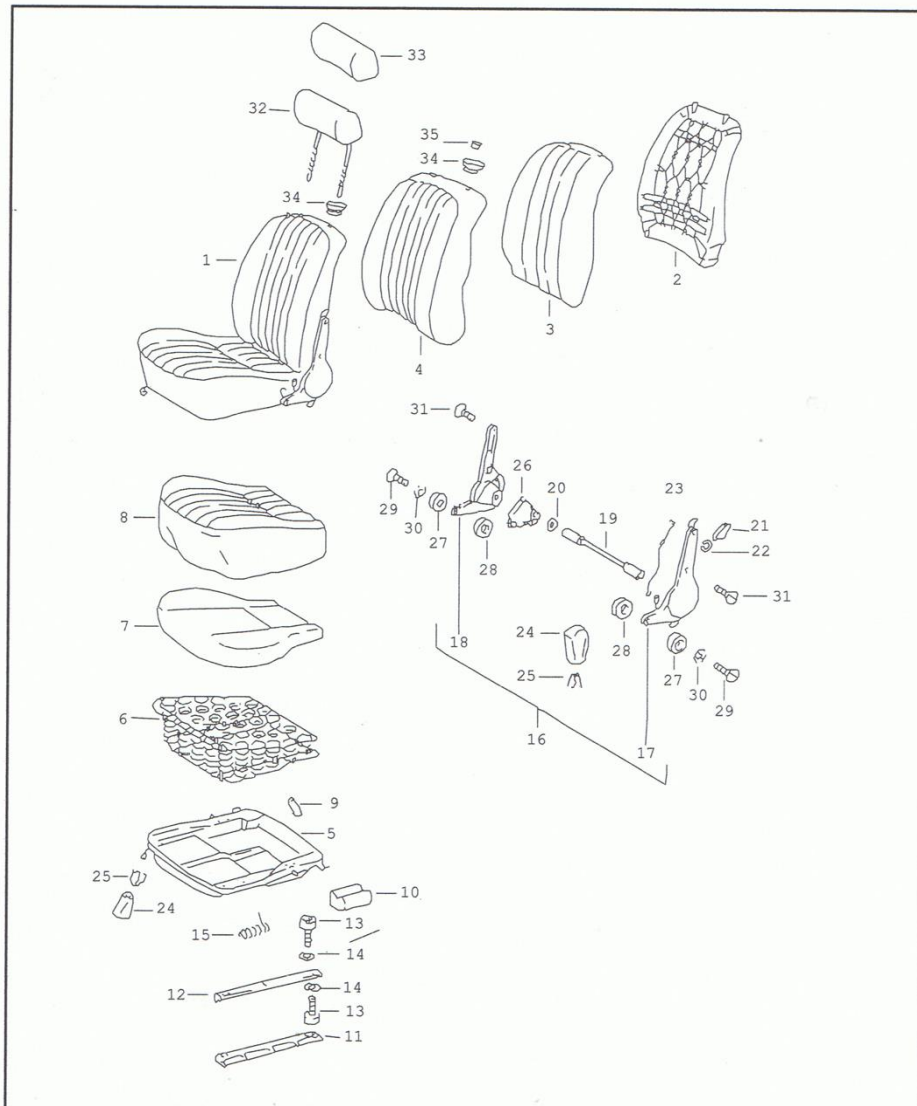

Back rest covers, per seat for 356/912/911/SC/911 3.2/964/924/944/968

1.	Cloth/vinyl	£336	B
2.	All leather	£407	B
3.	All leather/Perf centres	£437	B
4.	Leather/cloth	£372	B
5.	Leather/cloth/vinyl	£372	B

For Sports Seat options & Special Order Colour £POA

Front seats, per seat for 356/912/911/SC/911 3.2/964/924/944/968

1.	Cloth/vinyl	£282.11	B
2.	All leather	£332.62	B
3.	All leather with perf centres	£390.12	B
4.	Leather/cloth	£316.83	B
5.	Leather/cloth/vinyl	£316.83	B

For Sports Seat options & Special Order Colour £POA

Early RS Sports Seat parts, Pre 1974

1.	Complete reproduction seat less sub-frame	£POA	B
2.	Re-spray hinges in OE Crackle finish	£78.75 each	
3.	Foam seat bolster, LH or RH	£60.90 each	D
4.	Foam seat cushion	£48.30 each	D
5.	Foam backrest bolster, LH or RH	£68.25 each	D
6.	Foam backrest centre cushion	£46.20 each	D
7.	Set of 6 foams for 1 complete seat	£357.00 per set	B
8.	Elastics x 4 pieces for early RS touring seats	£31.50 per set	D
9.	Elastic off the roll	£10.50 per metre	D
10.	Early headrest	£153.30 each	C
11.	Elap repro head rest	£168.00 each	
12.	Early headrests covers, vinyl	£21.00 each	B
13.	Early headrests covers, leather	£26.25 each	
14.	M8 Stainless Phillips machine screws	£1.05 each	B
15.	Early type tipping console	£POA	
16.	Rs sports subframe restoration, strip, shotblast, paint	£171.15	
17.	Head rest Ferrell for sports seat (1973)	£8.93	
18.	Wire Clips for Elastic webbing	£1.50 each	

Early RS lightweight seats

1.	RSR Type, retrim only, black cloth & no foam work	£759.15	per pair	B
2.	RSR Type, foam or refoam	£160.65	per pair	B

Piping

1.	Piping, leather supplied ready to use per 80" length	£30.98		D
2.	Piping, vinyl supplied ready to use per 80" length	£20.48		D
3.	Pre-made cushion piping various colours, not OEM, vinyl	£2.63	per metre	
4.	Pre-made cushion piping various colours, not OEM, Plastic	£1.31	per metre	

Foam

1.	Base units for 2.7/SC/924/944/3.2/964 subject to availability			
2.	Foam bolster for standard sports seats 1975 to 1983 911	£P.O.A		B
3.	Foam backrest for standard sports seats 1975 to 1983 911	£P.O.A		B
4.	Foam rear seat pads for 911 2.4/Sc/3.2	£36.75	each	D

RS seats, Recaro / SPG / Pole positions / mounts / runners:

1.	Pre '74 mount (from runners to floor)	£75.00	per set (1 Seat)	
2.	Pole Position Side Mounts (ours)	£95.00	per set (1 Seat)	B
3.	Double Locking Runners Recaro	£98.33	per seat	A
4.	Base frame and adaptors available for all the above from	£ POA		B
5.	Recaro Sport trimmed by us in OE + colours to OE spec	£ POA	each	B
6.	Seat runners with double angle bracket	£98.33	per seat	A
7.	Side mounts, black steel, with Recaro on sides	£140.83	per seat	A
8.	Shells painted-sprayed in OE Porsche colours	£157.50	each	A
9.	SPG ready to fit 3.2 964/993, install leather including perf	£1,820.70	each	B
10.	RS 92 Shell Bucket/SPG seat, retrim in leather including perf	£880.95	each	B
11.	RS 92 Shell Bucket/SPG seat, retrim in cloth, from	£759.15	each	B
12.	RS 92 Shell Bucket/SPG seat, retrim in leather, 3 colour cushions	£1,071.00	each	B
13.	RS 92 shell bucket? SPG seat retrim in leather, 2 colour (993)	£970.20	each	B
14.	Replacement RS seat cushion set (pair), leather with perf centre	£ POA	each	B
15.	Retrim original cushions in perforated leather or Alcantara	£473.55	per seat	B
16.	Retrim cushions only in OEM cloth or vinyl	£436.80	per seat	B
17.	RS 92/Outer horseshoe cover supplied & fitted in leather	£601.65	each	B
18.	RS 92/ Outer horseshoe cover supplied in leather	£516.60	each	B
19.	RS 92/ Outer horseshoe cover supplied & fitted in cloth	£471.45	each	B
20.	RS 92//968 Outer horseshoe cover supplied in cloth	£413.70	each	B
21.	Alloy Spacer, 25 x 5 x 8, for SPG, Pole position etc	£2.10	each	
22.	Air lumbar, larger, clear with inflator	£P.O.A		
23.	SPG/Pole position bolts kit: 4x M8x25; 6x M8 shallow head 8x M8x30; 1x 3 hole plate, M8 Nylock nuts	£9.45	for 2 seats	
24.	Set of cloth B80 covers for all cushions 968 CS	£358.05	per seat	
25.	Set of cushion covers for RS 92 964 triple colour leather	£665.70	per seat	
25A.	993 RS single colour grey E23 leather cushion covers per seat	£601.65		
25B.	Set of foam cushion parts RS 964 per seat + 968 cs + 993 RS	£122.00		
26.	Set of single colour Alcantara cushion covers £446.13 supply	£649.95	fitted per seat	
27.	Set of O.E.M cloth Recaro SPG seat and cushion covers	£267.75	per seat	
28.	Lumbar pad RS / speedster / 968 supply	£30.45	each	
29.	Wedge foam RS 964	£42.00		
	trimmed	£96.60		
30.	Cloth with black leather, bond to shell	£50.40		
	fitted	£79.80		
31.	SPG / Pole cover supplied (off seat) by customer Porsche crest	£53.55	each	
32.	Porsche embossed crest	£48.30	each	
33.	Pole/SPG Seat Belt Rose and Screw Set = 2 Roses/4 Screws	£18.11		
34.	One off leather (min 1 x hide approx. 5m ²)	£P.O.A		
35.	Special order Porsche OEM colour leathers per pair seats from	£289.00	extra	
36.	SPG black cloth cover	£140.70		
37.	Fitting of covers to new foams	£43.31	per seat	
38.	5 piece cut foam part set = bolster + headrest 968 cs/964 RS/993 RS	£82.43	per set	
39.	Seat tension wires – SPG. Pole	£15.75	each	

INTERIOR PANELING

911 Pillar trims:

1.	B Pillars, fitted on own, lower part, leather	£102.90	each	B
2.	B Pillars fitted as part of retrim, lower part, leather	£73.50	each	B
3.	B Pillars fitted on own, lower part, vinyl	£86.10	each	B
4.	B Pillars fitted as part of retrim, lower part, vinyl	£61.95	each	B
5.	B Pillars supply only, lower part, black leather (colours POA)	£39.00	pair	B
6.	B Pillars supply only, lower part, vinyl (coupe+targa+cab)	£29.00	pair	B
7.	B Pillar uppers, coupe, fitted. Leather	£78.75	each	B
8.	B Pillar uppers, coupe, fitted. Vinyl	£65.10	each	B

PLEASE NOTE ALL PRICES ARE UNDER REVIEW FOR 2023 AND MAY NOT BE AS PRINTED BELOW

9.	B Pillar uppers, coupe, supply only, black leather (colours POA)	£35.00	pair	B
10.	B Pillar uppers, coupe, supply only, vinyl	£27.00	pair	B
11.	B Pillar uppers, Targa 993, leather fitted with retrim	£67.20	each	B
12.	B Pillar uppers, Targa 993, vinyl fitted with retrim	£52.50	each	B
13.	A Pillar upper, when fitted with dash, black leather.(coupe) (colours POA)	£73.50	each	B
14.	A Pillar upper, when fitted with dash, vinyl. (coupe)	£58.80	each	B
15.	A Pillar supply only, leather (coupe)	£38.50		D
16.	A Pillar supply only, vinyl (coupe)	£28.50	pair	B
17.	Targa roll bar forward part trimmed & fitted, vinyl	£207.90		B
	supply	£36.23		
18.	Targa roll bar, slot in part trimmed & fitted, vinyl	£216.30		B
	supply	£40.95		
	out of car	£172.20		
19.	Targa 3pc windscreen surrounds	£68.25	supply	D
20.	Targa front windscreen frame surround (+cab) screen out	£521.85		
	dash out	£554.40		

Door Bins:

1.	Door Bins, OEM originals trimmed ready to fit	£400	each	B
2.	Door Bins, aftermarket trimmed ready to fit (Bare £177)	£259	each	B
3.	Door Bins, OEM originals untrimmed	£320	each	B
4.	O.E.M 2 part door bins 68-74	£POA		
5.	Door bins re carpeted	£100		
6.	RS 964 seat belt cover untrimmed	£89	each	B
	in OE 5FV black carpet	£118.65	each	B

Panel sets:

1.	2 door panels with stitched detail 911SC/3.2/964, supplied, leather	£449.40		C
2.	2 door panels with stitched detail, supplied and fitted, leather	£538.65		B
3.	2 door panels with stitched detail, supplied, vinyl/ cloth	£372.75		C
4.	2 door panels with stitched detail, supplied and fitted, vinyl	£479.85		B
5.	2 door panels, plain, supplied, leather 74-77	£328.65		C
	fitted	£418.43		C
6.	2 door panels, plain, supplied, vinyl/cloth 74-77	£311.85		C
	fitted	£397.95		C
7.	2 door panels, supplied, untrimmed but inc ¼" foam	£93.45		D
8.	2 door panels for up to 1968, 911 with pockets, leather. Supplied	£591.15		B
9.	2 door panels for up to 1968, 911 with pockets, vinyl. Supplied	£507.15		B
10.	2 door panels 912 with elasticated pocket, leather supplied	£497.70		B
11.	2 door panels 912 with elasticated pocket, vinyl supplied	£425.25		B
12.	2 door panels for OE door bin arrangement, 1968-1974, leather supplied	£321.30		B
13.	2 door panels for OE door bin arrangement, 1968-1974, vinyl, supplied	£263.55		B
14.	2 door panels for OE door bin arrangement, 1968-1974, leather, supplied & fitted	£392.70		B
15.	Door panel cover parts, 911 Sc/3.2, leather	£155.40	each	D
16.	Door panel cover parts, 911 Sc/3.2, vinyl	£122.85	each	D

Capping sets:

1.	Capping set of 4 pieces along front & rear panels,	Leather	£150.68	C
2.	Capping set of 4 pieces along front & rear panels,	Vinyl	£118.65	C
3.	Capping set of 4 pieces along front & rear panels, Leather Targa/993		£163.80	C
4.	Capping set of 4 pieces along front & rear panels, Leather, cut parts only		£84.00	C
		Vinyl	£50.93	C
5.	Capping set of 2 pieces along front panels only,	Leather	£102.90	C
6.	Capping set of 2 pieces along front panels only,	Vinyl	£80.85	C
7.	Capping set of 2 pieces along rear panels only, Targa/Coupe,	Leather	£57.75	C
8.	Capping set of 2 pieces along rear panels only, Targa/Coupe,	Vinyl	£54.60	C
9.	Capping set of 2 pieces along rear panels only, Targa/993,	Leather	£127.05	C
10.	Capping set of rear pair cut parts	Vinyl	£19.43	
		Leather	£29.40	

Supply only ready to fit 911

1.	Front door panels, leather including infills for 993, exchange part	£518.70	pair	C
2.	Front door panels, vinyl, including infills for 993 exchange part	£405.30	pair	D

INTERIOR PANELS

911 1968 to 1974

911(993) 1994 to 1998

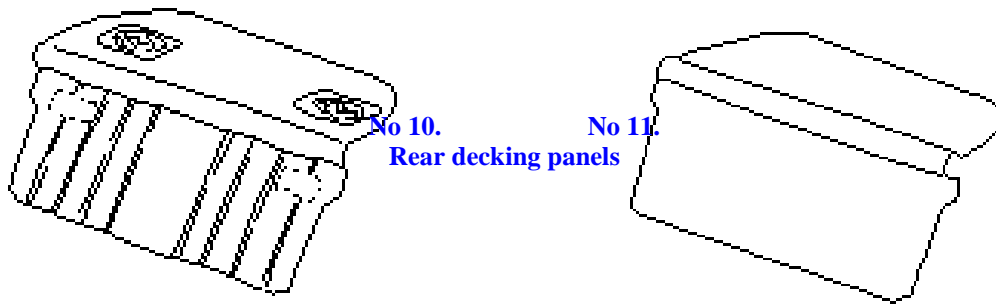
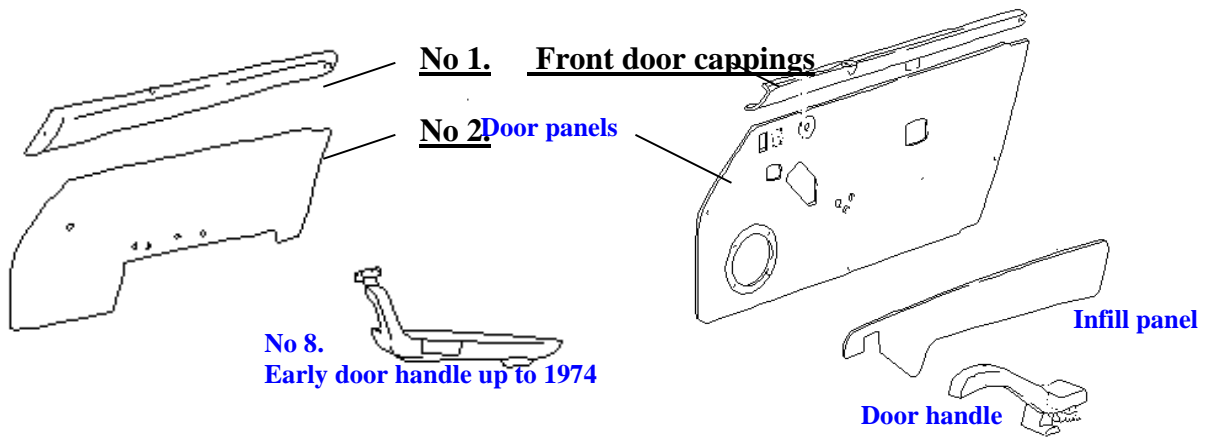

No 13.
911 1968 to 1974
Forward door bin

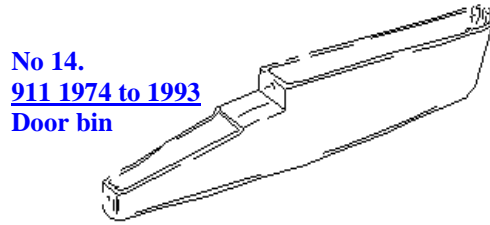
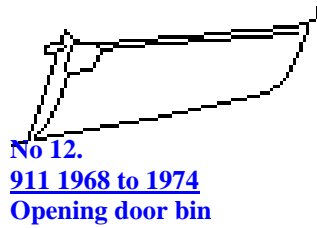
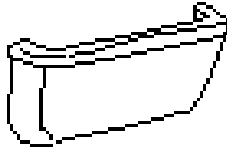

911 1976 to 1993

No 3.
Front door capping

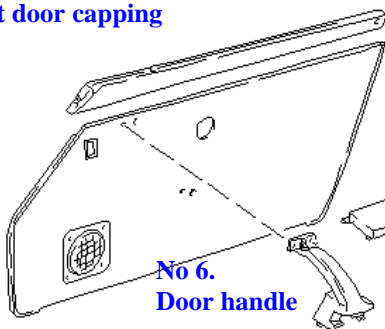

No 4. Door panel.

No 5. Door bin lid

No 16.
Lower 'B' Pillar trim
Cover Padding

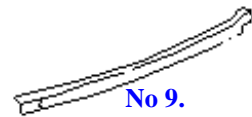
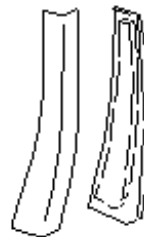

INTERIOR PANELS

RS door panels and parts, Late Type

911Sc/3.2/964/993

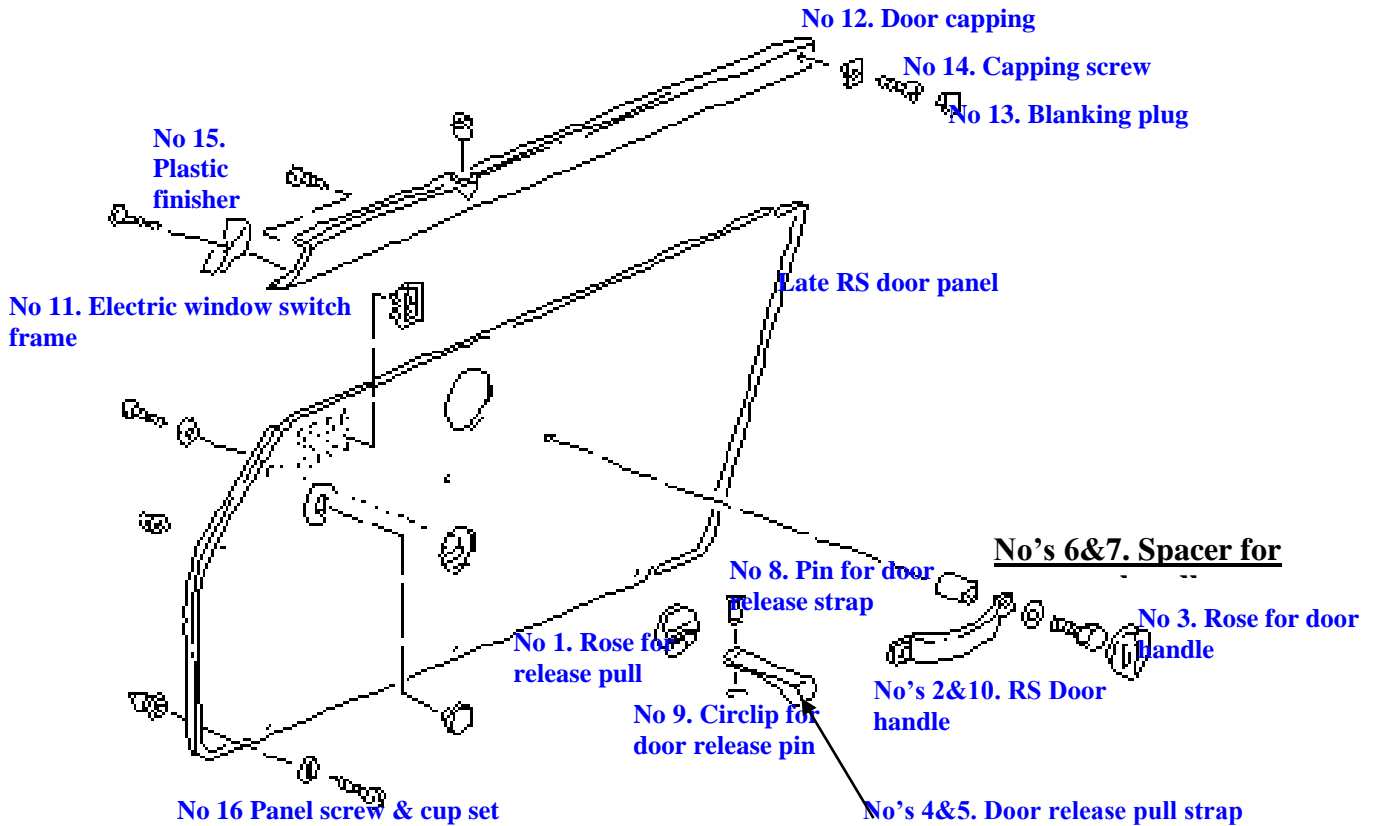

Options on panels (continued)

- | | |
|--------------------------------------|---|
| 7. Spacer for handle, ours | B |
| 8. Pin for door release strap | B |
| 9. Circlip for door release pin pull | B |
| 10. 964 RS '92 door handle, leather | B |
| 11. Electric window switch frames | B |
| 12. Door capping | |
| 13. Blanking plug | |
| 14. Capping Screw | |
| 15. Plastic finisher | |
| 16. Panel screw and cup | |

993

1.	993 door panels including infill panel, retrim and fit in Leather	£567.00	pair	C
2.	993 door panels including infill panel, retrim and fit in Vinyl	£444.15	pair	C
3.	Supply cut parts in leather for panel only, not infill	£155.40	pair	C
4.	Supply cut parts in vinyl for panel only, not infill	£86.10	pair	C
5.	993 infill panels OE leather retrim only (exchange required)	£129.15	pair	B
6.	993 infill panels OE leather retrim and fit (exchange required)	£268.80	pair	B
7.	993 infill panels OE leather supply only of cut leather parts	£66.15	each	D
8.	993 infill panels vinyl retrim only (exchange required)	£105.00	pair	B
9.	993 infill panels vinyl retrim and fit (exchange required)	£242.55	pair	B
10.	993 Targa header rail in leather, supply cut leather parts only	£55.65	each	C
11.	993 Targa header rail in leather, fit as part of retrim	£82.95	each	B
12.	993 Targa header rail in vinyl, fit as part of retrim	£61.95	each	B
13.	993 Targa lateral roof rails, supply cut leather parts only	£61.95	each	C
14.	993 Targa lateral roof rails, leather, fit as part of retrim	£89.25	each	B
15.	993 Targa lateral roof rails, vinyl, fit as part of retrim	£73.50	each	B
16.	993 Pair door panels with infills supply	Leather £546.00		B
		Vinyl £441.00		

Early RS door panels and parts, Pre 1974

Early Pre '74 RS door panels c/w handles & fittings in leather	£476.70	pair	C
Early Pre '74 RS door panels c/w handles & fittings in vinyl/cloth	£405.30	pair	C
Untrimmed door panels Inc ¼" foam	£92.93	pair	D

Options on panels

1.	Handle	2	£16.80	each	D
2.	Strap	2	£12.60	each	B
3.	Panels in vinyl no fittings	2	£310.80	each	B
4.	Nutserts	3	£0.42	each	B
5.	M4 x 25 machine, panel fixing	5	£0.42	each	B
6.	M6 Allen bolts x 25, strap fixing	2	£0.42	each	B
7.	M5 x 25 Counter sunk handle fixing	4	£0.42	each	B
8.	Protection washer	6	£0.32	each	B
9.	Panel protection edging '		£4.20	per metre	C
10.	Panel protection edging roll price 50 metres / roll		£3.15	per metre	

RS door panels and parts, Late type

911SC/3.2/964/993

Late RS door panels c/w handles & fittings in Leather for SC/3.2/964/993	£605.85	pair	C
Late RS door panels c/w handles & fittings in Vinyl for SC/3.2/964/993	£535.50	pair	C
Late Rs door panels supplied and fitted	Leather £828.45	pair	
	Vinyl £782.25	pair	
Late RS door panels, no fittings, in vinyl for SC/3.2/964/993	£308.70	pair	C
Late RS door panels, no fittings, in leather for SC/3.2/964/993	£337.05	pair	C
Late RS door panels, untrimmed, includes ¼ foam , panel clips	£92.93	pair	D
Pockets plain elastic type	£56.70	pair	
Pockets, picture frame type	£164.85	pair	

Options on panels

1	Rose for release pull	£3.68	each	B
2	RS door handle, 993 type only	£102.90	each	B
3	Rose for door handle	£3.68	each	B
4	Door release pull strap, OEM webbing	£34.65	each	B
5	Door release pull strap, ours in leather	£11.55	each	B
6	Spacer for handle, OEM	£4.73	each	B
7	Spacer for handle, OUR TYPE	£2.63	each	B
8	Pin	£1.58	each	
9	Circlip	£1.58	each	

10 Window switch frame

£6.08 each

Wheel arch panels – may require exchange item or £80.00 surcharge

911/912/2.4/2.7 / 930 / 3.2 / 964 / 993 1965 to 1998 (special order colours extra £POA)

1.	Rear two-part wheel arch panels trimmed in leather	£358.05	per pair	B
2.	Rear two-part wheel arch panels trimmed in vinyl/cloth	£320.25	per pair	B
1.	Rear two-part wheel arch panels, cut leather sections	£123.90	per pair	B
2.	Rear two-part wheel arch panels, cut vinyl sections	£69.30	per pair	C
3.	Targa wheel arch panels trimmed, leather	£233	per pair	B
4.	Targa wheel arch panels trimmed & fitted, black leather	£281.40	per pair	B
5.	Targa wheel arch panels, cut leather sections	£114.45	per pair	C
6.	Targa wheel arch panels in vinyl up to 1994 supply	£153.30	per pair	B
7.	Targa wheel arch panels, cut vinyl sections	£56.70	per pair	C
8.	Coupe wheel arch panels, retrimmed, leather fitted on own	£472.50	per pair	C
9.	Coupe wheel arch panels, retrimmed, vinyl fitted on own	£416.85	per pair	C
10.	Coupe seat belt panel 1969 to 1973 supply ready to fit leather	£141.75	each	
		vinyl	£114.45	each
11.	Retrim coupe seat belt panel leather	£48.30	each	C
		vinyl	£36.75	each

Rear parcel shelf– requires exchange item or £105.00 surcharge

1.	Rear parcel shelf re-trimmed in leather sc /3.2/964/993	£385.35		B
2.	Rear parcel shelf re-trimmed in vinyl/cloth sc /3.2/964/993	£343.35		B
3.	Sewn parts & plain parcel shelf panel vinyl/cloth supply	£151.20		C
4.	Sewn parts & plain parcel shelf panel leather supply (69 to 77 £167.00)	£245.70		C
5.	Rear decking top only, re-trim in leather	£357.00		D
		Vinyl	£306.60	D
6.	Rear decking top only, re-trim in leather and refit	£390.60		B
7.	Rear decking lower only, re-trim in leather, stitched	£315.00		B
8.	Rear decking lower only, re-trim in vinyl, stitched	£236.25		B
	'68-'77 plain type	£174.30		B
9.	Rear decking lower only, re-trim in leather, plain '68-'77	£279.30		B
10.	Rear parcel shelf one-piece type up to 69, leather	£368.55		B
11.	Rear parcel shelf one piece type up to 69, vinyl	£322.35		B
12.	Rear parcel shelf three parts 69-77, leather re-trim	£372.75		B
13.	Rear parcel shelf three part 69-77, vinyl re-trim	£319.20		B
14.	Rail for one piece shelf, leather Supply (retrim = £74.00)	£40.95		B
15.	Rail for one-piece shelf, vinyl Supply (retrim = £64.20)	£32.55		B
16.	Rear decking panel top section for 3.2 / 964,993 supply in leather	£85.05		
17.	Parcel shelf top section, vinyl with O.E speaker perforations supply	£91.50		
		Leather	£141.00	
18.	As above but using customer supplied material	£69.00		
19.	Supply rear shelf lower section with twin stitching in black leather (colours POA)	£116		
20.	Rear decking one piece type up to 1969 pre-cut panel board only	£185.85		B
21.	Pre cut top and lower rear deck parts – from	£30.45	each	B
22.	Metal bracket for rear panels	£5.25	each	

We can supply donor parcel shelves for certain models

POA

TRIM, GENERAL

911/964/993:

Dashboard parts

1	Dash centre strip early car, vinyl plain/basket weave, supply only	£26.25		E
2	Dash centre strip early car, leather, supply only, up to 1973	£42.00		D
3	Dash centre strip remove, retrim and refit, up to 1973	£207.90		D
4	Dash centre strip retrim (removed from car)	£77.70		
5	Lower dash 993 all colours, trim in leather	£470.40		B
6	Lower dash 993 all colours, trim and fit in leather	£622.65		B
7	Lower dash cover, supply only	£262.50		C
8	Dashboard centre strip & clocks surround, leather, trim only, 74 to 98	£304.50		C
9	Dashboard centre strip & clocks surround, leather, trim and fit, 74 to 98	£537.60		B
10	Dash centre strip sections in leather, without clock surround	£399.00		
11	Supply of thinned (0.5mm) leather for centre dash 911 SC/3.2/964/993 Dashboard already removed by customer, retrim in leather (subject to cond')	£71.40		
12	£609.00	£639.45		B
13	Dashboard already removed by customer, retrim in vinyl (subject to cond')	£494.55		B
14	Dashboard top, leather, trim and fit, all models pre 1987 Carrera (wind screen out)	£846.30		
15	Dashboard top, leather, trim and fit 3.2 / 964 / 993	£729.75		
16	Dashboard cover, supply only, black leather (vinyl £195.00)	£288.75		C
17	Leather black for 911 around dials supply (vinyl £17.00)	£46.20		D
17A.	As above other colours	£POA		
18	Set of 5 dial bezels, 911 up to 1998, retrimmed in leather	£539.70		B
19	Windscreen surround, cabrio/targa fitted in leather	£425.25		B
20	Tread plates retrimmed in leather (964/993)	£60.90	pair	
21	Demister slot late 3.2/964/993 paint	£37.80		
22	Dash top vinyl section, early 65-68 with OE speaker perf	£79.28		C

Door parts

1.	Door pulls with hand-stitched seam, leather 911SC/3.2/964	£319.20	pair	B
2.	Door pulls with hand-stitched seam, leather 993	£334.95	pair	B
3.	911/964 Door pull covers, leather	£155.93	pair	C
4.	Door pull covers leather 993	£160.65	pair	C
5.	Door bin lids, leather	£262.50	pair	B
6.	993/911/964 Door bin lid covers, leather	£142.80	pair	C
7.	Early handles 911/912 up to 1967 retrim vinyl, subject to condition	£210.00	pair	B
8.	Early handles 911/912 up to 1967 retrim leather, subject to condition	£247.80	pair	B
9.	Early handles 911 1969-1974 if repairable, retrim leather	£406.35	pair	B
10.	Handle covers supplied in vinyl	£116.55		
11.	Handle covers supplied in leather	£153.30	pair	B

Centre console

1.	Centre console 964/993 Carrera 2+4 1989 onwards, retrimmed in leather	£357.00	B
2.	Centre console 964/993 Carrera 2+4 1989 onwards, retrimmed in leather & fitted	£427.35	B
3.	Centre console 964/993 Carrera 2+4 1989 onwards, retrimmed in OE vinyl	£181.65	B
4.	Centre console 964/993 Carrera 2+4 1989 onwards, retrimmed & fitted in OE vinyl	£279.30	B
5.	Centre console 911 SC/3.2, trim only, vinyl (with retrim price)	£82.95	B
6.	Centre console 911 SC/3.2, trim only, leather (with retrim price)	£97.65	B
7.	Centre console 911 SC/3.2, trim and fit	£157.50	B
8.	Centre console 911 SC/3.2 supply vinyl cover	£52.50	C
9.	Centre console 911 SC/3.2 supply leather cover	£74.55	C
10.	Centre console 964/993 supply cover only leather	£206.85	C
11.	Centre console unit SE complete - 4 parts trimmed in leather	£259.35	B
12.	Centre console 964/993 cut section of plain leather without stitch detailing	£61.95	B
13.	Centre console rear cup 911SC / 3.2 in leather with twin stitch	£98.50	

Knee Rails/Gear Gaiters

1.	Knee rails including ashtray 911 SC/3.2, leather, trim only	£131.25	set	B
2.	Knee rails including ashtray 911 SC/3.2, leather, trim and fit	£190.05	set	B
3.	Knee rails and ashtray late 3.2 and 964, leather, trim only	£162.75	set	B
4.	Knee rails and ashtray late 3.2 and 964, leather, trim and	£215.25	set	B
5.	Knee rails including ashtray, covers in leather for up to '85	£89.25	set	B
6.	Knee rails including ashtray, covers in leather for '85- '93	£119.70	set	B
7.	Knee rail one piece 912/911 in leather	£102.90		B
	in Vinyl	£76.13		
8.	Knee rail one piece 912/911 in leather, fitted	£170.10		B
9.	Knee rail one piece 912/911 in vinyl fitted	£121.80		B
10.	Under dash pockets / below knee rail SE component trimmed in leather	£168.00	each	B
11.	Ashtray retrimmed in leather up to 1994	£28.35	each	
12.	Sun visors, retrim in leather	£432.60	pr	B
13.	Sun visors, RS/Speedster, retrim in leather	£143.85	pr	B
14.	Gear gaiter Carrera 2+4 1989 onwards, retrimmed	£143.85		C
15.	Gear gaiter Carrera 2+4 1989 onwards, retrimmed and fitted	£202.65		B
16.	Gear gaiter 911 SC/3.2	£85.00		E
17.	Gear knob up to 1989 3.2/Turbo/S/Tiptronic 964 993	£52.50		B
18.	Handbrake lever cover in leather supply only 964/ 993	£78.00		C
19.	Handbrake gaiter 911SC/3.2, supply only	£78.00		D
20.	Handbrake lever 964/993, retrimmed	£106.05		D
21.	As above but with twin stitch detail	£122.85		
22.	Gear gaiter cover 924/944/968/964/993	£85.00		

Steering wheels, horns and column parts

1.	Steering wheel, 3 spoke 911 SC/924/early 944, retrim in leather	£498.75		B
2.	Steering wheel SC column, half sections 0.5mm leather, supply only	£38.85		B
3.	Steering wheel SC column, half sections, supply and fit	£108.15		B
4.	Steering wheel, 4 spoke 1972 2 layer RS/3.2/964/993 retrim in leather	£604.80		B
5.	Steering wheel , 4 spoke up to 1976 single wrap	£536		B
6.	Steering wheel 3 spoke SE slant nose	£589.05		B
7.	Steering wheel section for trimming wheel, from (approx. 130 x 25 cm)	£89.25		D
8.	Horn push, SE component, 911 3 spoke trimmed in leather	£68.25		B
9.	Boss & cup, SE component trimmed in leather	£67.20		B
10.	Standard 4 spoke 3.2 / 964 horn pad in leather with Porsche logo retrim	£68.25		B

11. Embossing charge, leather Porsche logo for horn pad £32.55 D

924/944/968:

Door Panels (your panels retrimmed)

1.	Upper capping part of door panel in leather in 0.7mm leather (off car)	£217.35	pair	B
2.	968 Lower panels in leather with original stitch detail	£618.45	pair	B
3.	968 Lower panels with original stitch detail in vinyl	£522.90	pair	B
4.	924/944 Lower panels in leather plain, no stitch detail	£500.85	pair	B
5.	924/944 Lower panels in vinyl plain, no stitch detail	£465.15	pair	B
6.	924/944 Lower panels with original detail in leather	£628.95	pair	B
7.	924/944 Lower panels in cloth	£465.15	pair	B
8.	Armrests in leather	£414.75	pair	B
9.	Gear Gaiter	£143.85		
	Cover part / retrim	£75.60		
10.	Hand brake lever retrim in leather	£134.40		
	fitted	£180.60		
11.	Centre console with lid trimmed in leather, fitted	£462.00		B
12.	Factory leather console supplied by customer, retrimmed and fitted	£563.85		B
13.	924/early 944 centre console lid and surround	£121.80		B
14.	924/early 944 forward console	£268.80		
15.	Centre console in leather, trim only (not remove or refit)	£382.20		

Dashboards

1.	924/944/968 Complete oval dash trimmed and fitted in leather	£1,664.25		C
2.	Lower dash area/glove box trimmed in leather	£578.55		B
3.	Lower dash area/glove box (factory leather) retrim in leather	£714.00		B
4.	924/early 944 square dash retrim in leather (not removal or refit)	£928.20		C
5.	968 club sport style luggage dump	£414.75		

Rear wheel arch panels 944/968 Coupe in detailed leather POA pair B

Trim, 928:

* All prices subject to condition of existing trim

1.	Full door panels fitted in leather (includes panel infills but not handles)	£1,042.65	pair	B
2.	As above but already removed from car in leather	£890.40	pair	
3.	Door panel inserts, trimmed in leather	£96.60	pair	B
4.	Door panel inserts, trimmed in leather including new boards	£158.55	pair	B
5.	Door panel insert boards	£56.70	pair	B
6.	Door panel upper parts, trim only	£206.85	each	
	out of car	£115.50	fitted	
7.	Large door handles/armrests leather (inc grab handles and folding bin lid)	£452.55	pair	
8.	Rear seat belt panels	£157.50	pair	B
9.	Manual gear gaiter trimmed onto knobs and carrying bracket in leather	£112.35		B
10.	Auto gear lever retrim only, leather	£81.90		
11.	Large panels around rear side windows leather fitted	£590.10	pair	B
12.	Large panels around rear side windows vinyl fitted	£453.60	pair	B
13.	Centre console forward section retrim only	£413.70		B
14.	Centre console forward section retrimmed and fitted	£668.85		B
15.	Dash retrim only (not inc binnacle)	£1,144.50		B
16.	Dash retrimmed and fitted (not inc binnacle)	£2,079.00		B
17.	Dashboard instrument binnacle in leather (removed from car)	£472.50		
18.	Dash glove box lid retrim	£74.55		
19.	Under dash shelf rails retrim only, leather with twin stitch detail	£76.65	each	
20.	Infill frame around gear lever, leather (0.5mm, carries clock)	£65.10	each	

PLEASE NOTE ALL PRICES ARE UNDER REVIEW FOR 2023 AND MAY NOT BE AS PRINTED BELOW

21.	Ashtray lid, forward centre console, leather (0.5mm)	£31.50	each	
22.	Centre console lid (forward)	£65.10	each	
23.	Centre console box (rear) vinyl retrim	£295.05		B
	Leather	£406.35		B
24.	3 piece tailgate trim (removed from car)	£111.30		
25.	Windscreen 'a' pillars (removed from car) vinyl	£110.25	pair	
26.	Windscreen 'a' pillars (removed from car) leather	£133.35		
27.	Door surround upper trims (check clips!)	£134.40	pair	
28.	Rear luggage cover (early models) in moquette	£248.85		
29.	Dash glove box lid retrim in leather	£78.75		

Trim, Boxster 986/911 996:

Dashboards

1.	Dash retrim and fit existing in leather	£1,469.16		B
2.	Dash retrim and fit vinyl to leather	£1,252.02		B
3.	Dash retrim only, leather out of car	£1,159.62		B
4.	Dash retrim only, vinyl to leather out of car	£943.64		B
5.	Cut part for dash top in leather inc knee rail section from	£437.75	state colour	
6.	Binnacle retrim and fit existing in leather	£396.17		B
7.	Binnacle retrim and fit vinyl to leather	£353.43		B
8.	Binnacle retrim only, leather	£250.64		B
9.	Binnacle retrim only, vinyl	£189.42		B
10.	Binnacle cover with stitch detail in leather supply	£224.07		
11.	Door panels retrim and fit, leather	£1,197.74	pair	B
12.	Door panels retrim and fit, vinyl to leather	£1,075.31	pair	B
13.	Door panels retrim only, leather	£964.43	pair	B
14.	Door panels retrim only, vinyl	£783.09	pair	B
15.	Door bin lids leather	£P.O.A	pair	B
16.	Door grab handles	£P.O.A	pair	
17.	Rear panels retrim and fit, leather	£1,025.64		B
18.	Rear panels retrim and fit, vinyl to leather	£854.70		B
19.	Rear panels retrim only, leather	£808.50		B
20.	Rear panels retrim only, vinyl to leather	£677.99		B
21.	Centre console in leather with stitch detailing, fitted	£698.78		
22.	As above but already removed from car	£488.57		
23.	Centre console pad set retrimmed in leather (5pcs)	£176.72		

Trim General, 356ABC:

1.	Panel set: 2 door panels with pockets	all in Leather	£1,350	B
	2 wheel arch panels	or in Vinyl	£1,110	B
	1 large rear decking panel assembly			

Note: Some door panels require more detail than others; this will affect the individual prices

2.	Rear Cabriolet panels, leather		£256.30	B
3.	Rear Cabriolet panels, vinyl		£212.30	B
4.	Dash top retrim and fit, leather		£382.25	B
5.	Dash top retrim and fit, vinyl		£287.10	B
6.	Dash top retrim only, leather		£256.30	B
7.	Glove box liner		£38.50	
8.	Door cappings, leather		£77.00	B
9.	Rear cappings, leather		£61.60	
10.	'B' Pillar trim supplied leather		£19.80	pair B
11.	'B' Pillar trim supplied vinyl		£13.20	pair B
12.	Door panel complete with pocket, metal strip and fixing screws/cups, leather	£628.00 pair	£690.80	B
13.	Door panel complete with pocket, metal strip and fixing screws/cups, vinyl	£539.00pair	£592.90	B
14.	Armrests, leather		£79.20	pair B
15.	Armrests, vinyl		£60.50	pair B
16.	Rear wheel arch panels, Coupe, leather		£262.90	B
17.	Rear wheel arch panels, Coupe, vinyl		£257.40	B
18.	Large rear decking panel, retrim leather		£258.50	B
19.	Large rear decking panel, complete new, leather		£354.20	B
20.	Large rear decking panel, retrim vinyl		£230.45	B
21.	Large rear decking panel, complete new, vinyl		£295.90	

CARPETS AND FLOORMATS

Approximate guide only.

Note: Real leather carpet edging per set from £78.75

Supply Only	Two front replacement floor carpets (O.E.)	Set of Four replacement floor carpets (O.E.)	Boot Carpet (O.E.)	Full carpet set (O.E.)
356ABC Coupe	250.43	364.93	N/A	Full Set = 831.29 ½ set Boucle if rubbers retained 604.17 B
356 Cab/Roadster	250.43	364.93	N/A	Full Set = 891.92 ½ set Boucle if rubbers retained 660.40 B
911 / 912	177.50 perlon	282.24 perlon	B 379.26 / P B 178.61 C	891.92 S&P /Boucle, 667.01 Perlon
911 up to 1974	S + P / Boucle 202.86 B	S + P / Boucle 305.39 B	B, SP 379.26 / B 178.61 C Perlon	891.92 / 891.92 S&P / Boucle, 667.01 Perlon
Early RS up to 1974	Perlon with no front floor carpets		£641.66 C	£766.24 Perlon C
911 1974 to 1989	189.63	284.55	**182.55 / 202.86 servo	C 816.95 (uk D10 £ 643.00)
RS+911 1983 to 1989 Cab	C 189.63	C 298.78	196.80 perlon C 379.26	C 866.57 (uk D10 £671)
911 1989 -964/993	C 189.63	C 298.78	C**379.26	C 845.62
911 1989-964/993 Cab	C 189.63	C 298.78	**379.26	C 896.33
RS 964/993/gt2	C 189.63	C 298.78	C 195.14	C 940.43 Including Logo
924/944	Not available mail order			Fitted In-House only
968	POA OEM	POA OEM	POA OEM	POA OEM
928	207.27	314.21 OE	202.86	C 931.61
Boxster/996	POA	POA	N/A	POA

**Deluxe and late boot sets for 911 up to 1989: Centre part only: £225.75 C, Sides: £71.40 each C
993 boot set in O.E interior carpet £361.20

Extras:

Overmats:

- | | | | | |
|-----|---|----------|---------|----------|
| 1. | Carpet for all models with logos/contrasting edge(standard over mats) | Set of 4 | £87.15 | B |
| | | Set Of 2 | £68.25 | B |
| 2. | OEM prices same as front replacement floor carpets | | | |
| | Plus Options: | | | |
| | Sewn crested badges | | £22.05 | pair |
| | Eyelets: mat black | | £6.30 | pair |
| | Eyelets: mats brass | | £4.20 | pair |
| | Leather heel pad | | £10.50 | |
| | Set of fixings 3.2, 4 long OEM | | £34.65 | |
| | Set of fixings: 964/944/933 OEM | | £22.05 | |
| 3. | Boxster/996 front overmats: OEM | | | B |
| 4. | 996 Set of 4, not OEM | | | |
| 5. | 924/944/968/928 overmats, not OEM: Boot overmats | | £71.40 | B |
| 6. | 964/993 '89 – '98 overmats, OEM: Set of 4 with fittings | | | |
| 7. | Set of 4 rubber fine fluted overmats, not edged or backed | | £88.20 | D |
| 8. | Set of 4 rubber fine fluted overmats, edged not backed | | £121.80 | D |
| 9. | Front pair of rubber fine fluted overmats, not edged or backed | | £68.25 | D |
| 10. | Front pair of rubber fine fluted overmats, edged not backed | | £86.10 | D |
| 11. | Overmats (velour pile) set of 4 Merc | | £182.70 | C |
| 12. | Overmats (velour pile) front pair only Merc | | £151.20 | C |
| 13. | Porsche crest large approx 100 x 85 mm | | £44.10 | each |
| | Porsche crest large approx small 70 x 55 mm | | £35.70 | each |
| 14. | Small Porsche carpet side logo | | £12.60 | each |
| 15. | Turbo logo for fold down back rest | | £24.15 | each |
| 16. | Porsche logo across carpet approx 300 mm | | £23.63 | each |
| 17. | Real leather edging on set of overmats plus | | £22.05 | |
| 18. | Carrera RS/GT/RS 3.6 | | £36.75 | each |
| 19. | Original type 928 Rubber heel pad + foot rest | | £131.25 | per seat |

356 Model B&C only, LHD only, rubber mats to original design:

2 large front mats £327.60 **B**, Front tunnel mat £113.30 **B**, Rear passenger mats £67.20 **B**

RS style carpet sets as per Cabriolet prices; Early RS = pre '72, Perlon **C**

Supplied and fitted		Two front replacement floor carpets (O.E.)	Set of four replacement floor carpets (O.E.)	Boot Carpet (O.E.)	Full carpet set (O.E.)
356A BC		£232.05	£303.45	£334.95	£1773.45, Part set £1372.356
356 Cab/Roadster		£232.05	£303.45	£334.95	£1939.35 part set £1521.45
912		£164.85 perlon	£266.70 perlon	£346.60 / £164.85	£1773.45 S/P, £1492 Perlon
RS 1970's					£1611.75 Perlon black
911 up to 1974		£187.95	£284.55	£184.80	£1822.65 S/P, £1564.50 Perlon
911 1974-1989		£176.40	£277.20	£367.50 / £181.65	£1,891.05
911 1983-1989 Cab& RS style		£176.40	£277.20	£369.60 / £178	£2,020.20
911 1989-964/993		£176.40	£277.20	£423.15	£1961.40 Targa/Coupe
911 1989-964/993 Cab& RS style		£176.40	£277.20	£180.60	£2095.80 RS/Cab
OEM Moulded and 944 boot carpet subject to availability-price on application	924				
	944				
	968				
928		£205.80	£304.50	£200.55	£2,076.90
Boxster/996		£78.75 OEM	£1246.35 OEM	N/A	POA

INDIVIDUAL CARPET PARTS (plus 10% on special order colours)

1.	Parcel shelf, OE carpet (backed)	£178.86	C
2.	Parcel shelf, Perlon	£121.51	C
3.	Parcel shelf, OE carpet cut part, Cab, 3.2/964	£85.74	C
4.	Parcel shelf OE carpet with logo, RS	£208.38	C
5.	Rear wheel arch 2-part (RS) (993 £ 34.39)	£63.59	C
6.	Rear wheel arch 2-part (RS) Perlon Pre 1974	£51.67	D
7.	Seat Pad (in perlon £ 14.75)	£30.66	C
8.	Seat Pad late RS style	£38.05	C
9.	Sill section all models 911SC/3.2	£56.78	C
10.	Sill section 964	£70.98	C
11.	Centre Tunnel Sc 3.2	£136.27	C
12.	Centre Tunnel Sc 3.2 Perlon	£106.74	D
13.	Pedal mat	£48.83	C or for Salt & Pepper B
14.	Pedal mat Perlon	£43.16	D
15.	Sill section pre '74, Salt & Pepper	£92.56	7.50%
16.	Sill section pre '74, perlon	£62.45	D
17.	Wheel arch section	£48.83	C
18.	Rear Tunnel Perlon	£53.95	D
19.	Rear Tunnel Salt & Pepper Pre 1974	£71.54	7.50%
20.	Wheel arch section lower (perlon£29.25)	£51.10	C
21.	Rear section 911SC/3.2/964 (perlon £31.50)	£62.45	C
22.	A' Pillar/map pocket	£86.88	C or for Salt & Pepper B
23.	A' Pillar/map pocket Perlon (single layer RS £23.50)	£69.27	D
24.	Fold down back rests	£56.22	C or for Salt & Pepper B
25.	Fold down back rests Perlon	£42.02	D
26.	Sill section long/full length 94 on 993	£117.54	C
27.	Rear tunnel hump & side parts 993 section	£159.56	C
28.	Rear Hump 911 SC 3.2/2.7 etc (in perlon£ 10.50)	£24.98	C
29.	Cabriolet carpet for panel	£32.37	C
30.	Centre tunnel rear C2/C4 964	£56.78	C
31.	964/993 Forward tunnel	£60.76	C
32.	Forward tunnel Pre 1974 Salt & Pepper	£81.76	
33.	Pod carpet 3.2	£22.71	C
34.	Lower side wall front 3.2 (In perlon£ 24.60)	£41.45	D
35.	964/993 RS Boot with pocket/millboard backing	£246.96	C
36.	Rear seat drop to footwell 911 3.2 (in perlon £ 30.90)	£51.10	C
37.	Rear seat drop to footwell pre 1974 Salt & Pepper	£64.17	
38.	Rear seat drop to footwell Perlon	£45.42	D
39.	Boot centre part 911, perlon	£141.95	D
	Pre 1968 double thickness	£178.00	
40.	Boot centre part 911, perlon, Deluxe type edged - Double thickness	£273.67	D
41.	Boot side part 911, perlon	£32.93	D
42.	Boot side part 911, Deluxe type	£86.30	D
43.	Forward tunnel, pre 1974 Salt & Pepper	£86.00	
44.	Forward tunnel pre 1974 perlon	£68.13	
45.	Door bin carpet section	£48.27	
46.	Welded heel pad carpet section @	£54.71	
47.	Rear seat pad skirt 1965-66	£45.20	each C

INDIVIDUAL CARPET PARTS

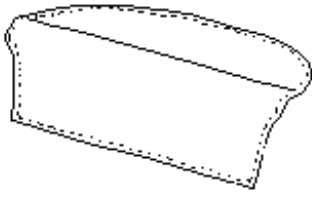

No 1 & 2. Parcel shelf

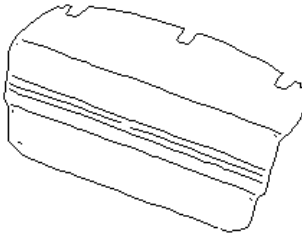

No 3. Parcel shelf cut part



No 4. Parcel shelf with logo

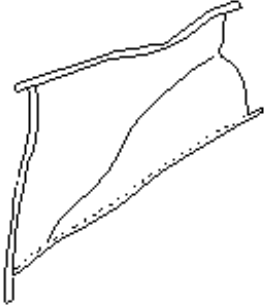

No 5 & 6. RS only, upper wheel arch to window section



No 7. Seat Pad

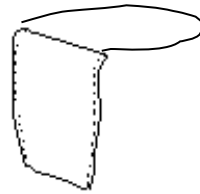

No 8. Seat pad, late RS style

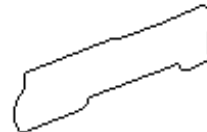

No 9. Sill sections all Pre '74 models 911 Sc 3.2



No 10. 964 Sill section

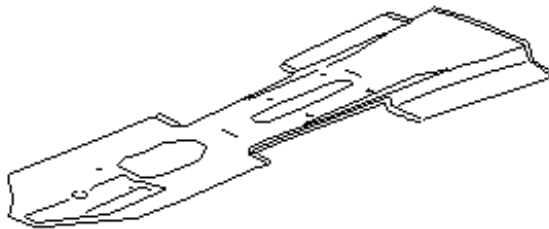

No's 11 & 12. Centre tunnel Sc 3.2



No 13 & 14. Pedal mat

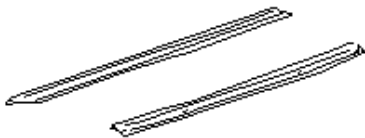

No's Tread Plates

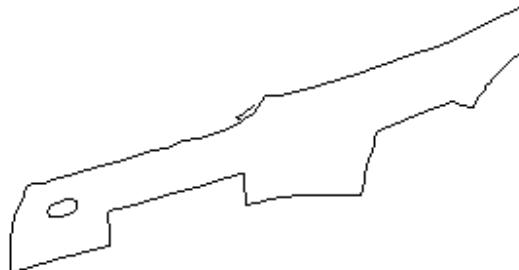

No. 15 & 16 Sill section

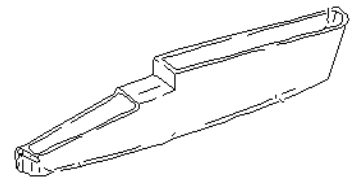

No 45. Door bins carpet section



No 18 & 19.



No 17 & 20 Wheel arch

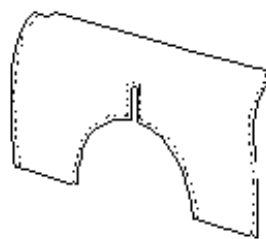

No 21. Rear



No 22 & 23. 'A' pillar/map pocket

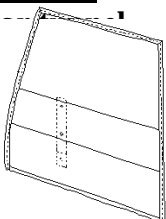

No's 24 & 25. Fold down

44. Forward tunnel, pre 1974 Perlon

£54.00 D



No 26. 993 only, combined sill and lower rear wheel arch

No 27. 993 only, combined tunnel/rear seating

No 28. Rear hump 911 Sc 3.2/2.7 etc

No 29. Carpet cabriolet for panel

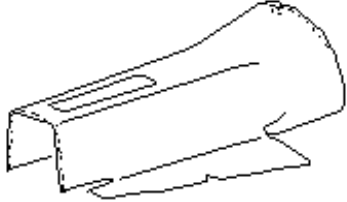

No 30. 964 rear centre tunnel



No 31. 964/993 forward tunnel section

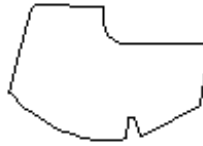

No 34. Lower sidewall front 3.2



No 35. 964/993 boot with pocket/millboard backing, RS

No's 36,37&38 Rear seat drop to footwell



No 39. 39a & 40 Boot centre part 911



No 41 & 42. Boot side part 911

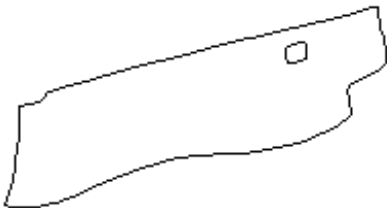

No. 43 & 44. Forward Tunnel Pre 1974

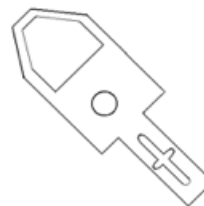

PLEASE NOTE ALL PRICES ARE UNDER REVIEW FOR 2023 AND MAY NOT BE AS PRINTED BELOW

HOODS & HEADLINERS	OEM Hood supplied List Price/	Full Hood supplied aftermarket using OEM materials	Front Hood section supplied	Rear Window section supplied	Full Tonneau supplied	Hood Cover (to cover hood when down) supplied (as drawing number 4)	Hood cover storage bag in mohair	Hood seal B-Post vertical supplied	Lateral Seal (top of side window)	Headlining Supplied
	Our o.e.m price									
Special Colours £46.00 per item extra										
356 cab / Roadster		655.94 A			737.10 A	333.90 B	79.80 D			298.20
911 (1967 onwards) Targa		156.87 D							151.20 B	88.20 D
911/912										241.50 C
911/912 Ivory/other OEM colours										241.50 C
911(1983)/911/964(85-94) Cabriolet		831.08 A	420.00 A	451.50 A	932.40 A	504.00 A	79.80 D	186.90 B	186.90 B	64.90 D
944/968 aftermarket (2 part)		715.05 A	420.00 A	451.50 A	850.50	504.00 A	79.80 D	POA	POA	415.80 C
944/968 OEM (2 part)		POA A	POA A	POA A						
Speedster 911 / 964		1046.33 A								
993 Hood - Window	POA	1046.33. A			910.35 A	504.00 A	POA	POA		617.40 C
Boxster hood		689.85								
Boxster hood glass window conversion	POA	741.30								
996 Hood plastic Window 97-02		1030.05 A								
996 Hood with glass window 02 and on		POA								
356 Cabriolet		813.75			733.95	37.80	64.05			313.95
Inner lining/padded section/new hood etc	Fitting =	£2,560.95	Hoods – fitting:							
Padding		£300.00	Boxster - fitting of hood							
			911/964/944/968 - fitting of hood (subject to condition)							
			Rear Section only - fitting							
			993 hood & window – fitting (subject to condition)							
			911/964 hood side tension wire – supply (993)							
			911/964 hood side tension wire - fitting							
			Only when fitting hood, not as individual job							
			Hood elastics pair fitted -							
			Only when fitting hood, not as individual job							
			Retrim 911 hood bow trim panel black vinyl							
			Headliners							
			911 headlining In Alcantara							
			911 Sunroof cover part, supply plain or perf							
			Colours							
			Ivory							
			Black							
			912/911 in beige(ivory) code 500 +							
			black code 700							
			911 Sunroof cover part, fitting							

HOODS

1. Hood

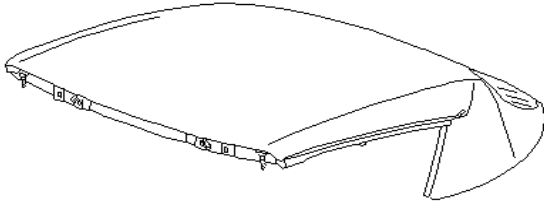

3. Full Tonneau

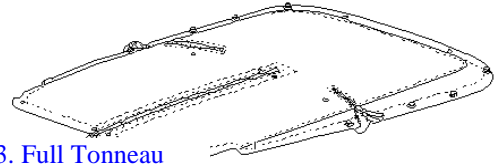

2. Hood Frame

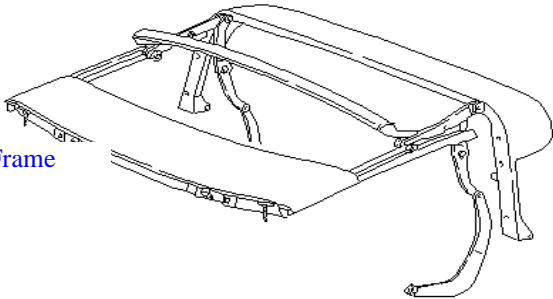

4. Hood Cover (Tonneau Cover)

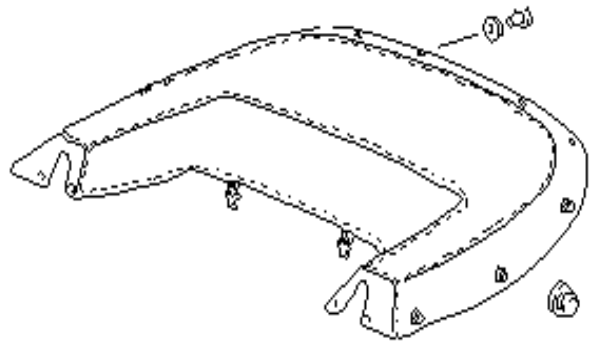

5. Hood Bag



911 TARGA UP TO 1994 ROOF PRICING

1.	Targa outer kit: supply with calico, foam & ½ litre glue	£185.85		D
2.	Targa outer kit: supply in Mohair with calico, foam & ½ litre glue	£257.25		D
3.	Fitting of outer cover	£543		B
4.	Fitting of foam, calico, webbing & tidy frame	£198.45		B
5.	Inner headliner: supplied with ½ litre glue	£88.20		F
6.	Fitting inner headliner (on own not with targa outer etc)	149.1		
7.	Make & fit inner headliner on own without rest of the roof	£199.50		C
8.	¼ lights: alignment, window height, adjust for best fit (Guide)	£260.40	pair	B
9.	Door membranes: OEM parts	£31.02	each	
10.	Door membranes:			
11.	Fitting: With door alignment	FOC		
12.	Fitting: If door is not being aligned per door	£97.65	+ parts	B
13.	Frame: Shot blast, etch prime & respray to original speckled finish	£185.85		A
14.	Metal Weather Strips: New OEM part, 2.7/911SC/3.2	£POA		B
15.	Reconditioned and powder coated	£21.00		B
15a.	964 weather strip	37.28	each	
16.	Front and rear webbing: mohair, complete with strip of 22 sets of compression rivets to secure webbing	£35.70		D
17.	Retrim Targa frame forward pad trims in black vinyl @	£29.93	each	
18.	Seals: Lower tubular door seals @	£39.90	each	B
19.	Rear Bar seal (Roll Bar), supply	£318.50		B
20.	Front Bar seal, supply 911,565,090,47 (blade type)	£185.00		B
21.	Front Bar seal late type (tube) 911,799,565,80	£287.00		B
22.	Fitting of all 4 seals, including cleaning out of channels etc	£199.50		B
23.	A lateral seal late type 89-94	£199.50	each	B
24.	Lateral seals @ 1969 to 1989 early type	£156.45	each	B
	Extras:			
25.	Targa roof locking handle (early & late)	£POA		A
26.	Targa dowel	£15.75		A
27.	Targa dowel threaded block	£6.30	each	A
28.	Targa hook catch	£POA		
29.	New Targa gutter channels OEM	£POA	as item 14	A
30.	Targa threaded 2-hole steel block	£6.00	each	D
31.	¼ Bracket	£9.45	each	
32.	¼ Clamp	£7.28	each	
33.	Plastic plugs & caps for rear bar seal (set)	£9.35	set	
34.	¼ light rubber top stop	£44.63	each	
35.	Fitting of top stop	£102.90	each	
36.	Retrim forward part rear roll bar trim	£20.48		
37.	Rear dowel plastic sheaf covers each	£8.93		
38.	Rivets for quarter lights in copper	£1.05	each	
39.	Brush strip for door slot outer	£31.50		
40.	Fitting of window lifter rail from	£135.19	each side	
41.	Rear roll bar plastic plug screws	£2.10	each	
42.	Rear roll bar rubber seals rear dowel	£3.15	each	
43.	Targa frame pad trim clips plastic	£1.58	each	
44.	Lock out latch – rubber coated	£14.49	each	

911 TARGA UP TO 1994

No's 1&2. Outer cover

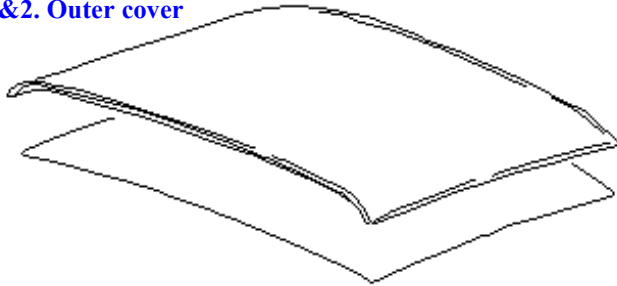

No 5. Inner cover

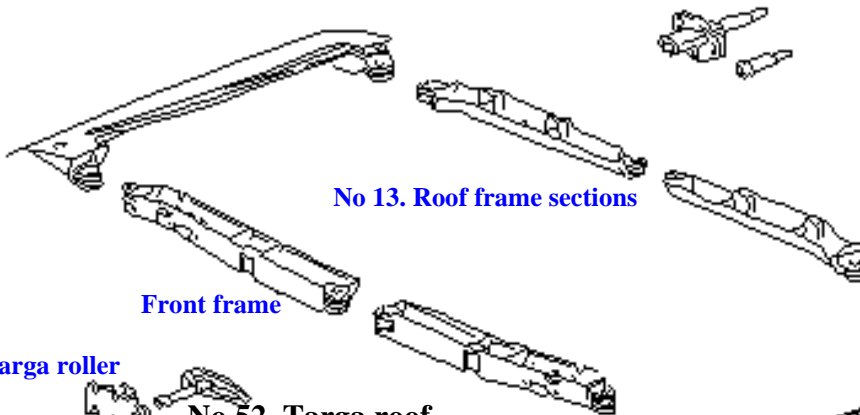

No 13. Roof frame sections

Front frame

No 55. Targa roller catch



No 52. Targa roof locking handle

No 51. Lateral seal

No 14& 15. Metal weather strips

No 51. Lateral seal

No 14 & 15. Metal weather strip

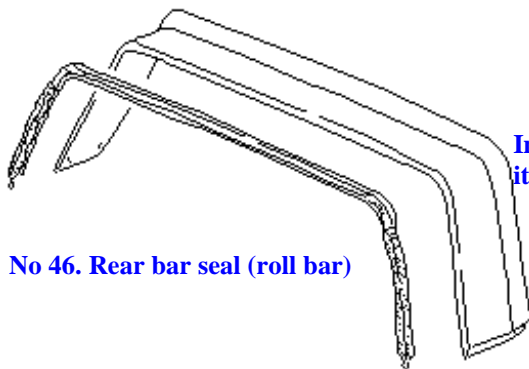

No 46. Rear bar seal (roll bar)

Inner roll bar trim, not itemised

FITTINGS

1.	Recaro air lumber pad and inflator	£46.73	inc	B
2.	DIY press stud tool with snaps (Popper Set)	£17.33	set	C
3.	Door Panel clips, plastic to secure panel to inner door skin	£0.87	each	D
4.	Door bin mounting block, front	£4.36	each	A
5.	Door membranes OEM	£29.93	each	
6.	Door membranes not, OEM	£9.45	each	
7.	Fasteners for boot carpets - stud on stainless steel plate	£5.41	each	D
8.	Front windscreen, green tint - not top tint/ariel type, supply only	£ POA		B
9.	Interior Mirror	£ POA		A
10.	Lever knob, to tilt seat forward 1974 to 1998	£3.26		C
11.	Backing plate/plastic behind lever	£4.36		C
12.	Seat heater with switch & thermostat control	£152.25	each	A
13.	Shifting wheel	£ POA		C
14.	Push-in cover for shifting wheel	£ POA		C
15.	Tenax German OE hood button, black finish	£7.61	each	D
16.	Tenax German OE hood button, chrome finish	£4.88	each	D
17.	Tenax OE hood stud, black finish (10mm £ 1.50)	£2.21	each	C
18.	Tenax OE hood stud, chrome finish	£1.89	each	C
19.	Tread plate in black on sill, carpet OEM	£38.85		A
20.	Tread plate in black on sill, aftermarket	£30.45		B
21.	Tread plate plastic SC-3.2 etc OEM on sill outer	£30.45	each	A
22.	Tread plate (carpet) Alloy OEM	£47.25		A
23.	Tread plate (carpet) Alloy, aftermarket	£36.75		B
24.	Phillips stainless machine screw M8x25, RS touring & sports seats	£1.10	each	B
25.	Screws, black finish, and surface cup washers	£0.29	each	D
26.	Screws, chrome finish, and surface cup washers	£0.29	each	D
27.	Allen bolts M8, shallow head for seat rails	£0.58	each	B
28.	Allen bolts for seats 6mm x 20mm black, hex cap bolt	£0.42	each	C
29.	Allen bolts for seats 8mm x 20mm '85 on, hex cap bolt, black	£0.58	each	C
30.	Straps for fold down backrest, long	£3.26	each	C
31.	Straps for fold down backrest, short (up to 10cm)	£2.21	each	C
32.	M8 Nylock nut	£0.12	each	D
33.	Press stud parts (poppers)	£0.42	each	D

SEALS

1.	Sunroof seal, brush type, short 911	£35.70		B
2.	Sunroof seal, brush type, long	£50.93		B
3.	Coupe door seal 911 up to 1993	£64.13		C
4.	Coupe door seal 911 1994 – 1998 (993)	£124.43		A
5.	911 front screen rubber for up to 1993	£75.08	each	B
6.	911 rear screen rubber for up to 1993	£75.08	each	B
7.	Targa and Cabriolet Lower tubular door seals	£38.85	each	B
8.	Rear side window seal, coupe (opening or fixed type) supply	£POA		
9.	Bonnet seal	£POA		
10.	Engine bay seals, pair one long, one short	£POA		

MATERIALS

VINYL

1. Blue / black pig skin vinyl + other special order vinyls	£58.38	metre	D
2. Basket weave not OE but good for early cars (inc. RS panel early)	£28.35	metre	D
3. Vinyl OEM various colours ,pebble grain 1984 to 98	£59.01	metre	C
4. Vinyl - selection available not OE	£26.25	metre	D
5. Vinyl – German, from	£55.65	metre	D
6. Early 644 smooth black vinyl perf to MK45	£59.33	metre	B
7. Repro 43S black vinyl 1984 to 1998 (BPX – 435)	£39.48	metre	C
8. Repro smooth black vinyl (black back) 708 & BSP 644	£30.45	metre	D

LEATHER

1. Import leather £91.20 per m/2 (min order 5 square metre)			
2. German, various colours, per hide, approx 50sq.ft	£417	approx per hide	
3. Thinned leather to 0.5mm (min charge £ 13.65)	£2.63	sq ft process fee	
4. ONE OFF SPECIAL @ £ 137.55 per m/2 (5 m/2 min order)			
5. Porsche OE perforation process fee 1/2 hide	£92.40		D
	or £25.20	per seat section	

CARPET

1. Merc velour carpet various colours 165 cm wide	£43.58	sq metre	D
2. Heel pad carpet with welded heel	£55.13	each	D
3. Carpet, wool pile, rubber backed, 1m wide	£43.26	sq metre	A
4. Carpet, German OE, 1.5m wide 911 / 928 (1975 – 1998)	£50.93	sq metre	C
5. Carpet as item 3 above special order / imports	£58.38	sq metre	D
6. Carpet salt & pepper type, early 1970's, 2.0m wide	£69.30	sq metre	7.50%
7. 356ABC boucle carpet <u>from</u>	£52.50	sq metre	B
8. 356ABC herringbone carpet cloth edge tape	£0.55	metre	C
9. Overmat carpet	£23.10	sq metre	
10. 40 mm wide cloth herringbone edging	£1.26	metre	
11. Bubble felt original floor carpet backing, 1.5mx1.0m sheet	£42.21		C
12. Rubber matting (fine fluted) 1.2m wide	£24.15	metre	B
13. Carpet edging in various original colours	£1.37	metre	D
14. Perlon	£20.58	sq metre	F
15. Sound proofing felt, 1.3mtrs wide x 12mm (1/2")	£20.58	metre	
16. Herringbone carpet edging cloth, 25mm	£0.38	metre	E
17. Carpet Boxster/996/Cayenne	£47.78	sq metre	D
18. Schlinge Mercedes black £ 45.75 m/2 , 2 tone colours	£54.08		
	to	£59.54	
19. Heel pad material 911 SC/early 3.2	£22.05		
20. Bubble felt on roll width 148cm	£30.45	metre	D
21. Leather edging 32 mm thinned to 0.7 mm	£3.80	metre	

CLOTH

1. Genuine and if in production and available, 1.4m wide, from	£72.45	metre	F
2. Hounds tooth check black / white @	£103.43	metre	B / D
3. B80 recaro sport cloth	£82.95	metre	

PLEASE NOTE ALL PRICES ARE UNDER REVIEW FOR 2023 AND MAY NOT BE AS PRINTED BELOW

4. Alcantara (standard colour range = 45 colours) £89.25 metre

ROOF MATERIALS

1.	Targa roof material OE, 0.9m wide	£ POA	C
2.	Targa roof material OE, 1.4m wide	£40.43 metre	C
3.	Mohair hooding, 1.4m wide from	£66.68 metre	D
4.	Headliner vinyl, perf & plain, Not OEM	£26.57 metre	E
5.	Headliner vinyl, perf & plain, OEM	£43.05 metre	D
6.	¼ " Foam running metre	£8.19 metre	D
7.	Headliner, Targa/Recaro black plain cloth	£43.26 metre	C

GLUES

1.	Contact adhesive, ½ litre	£10.50	can
2.	Contact adhesive, 1 litre	£20.48	can
3.	Spray glue	£4.73	can
	high strength	£9.98	can

WINDOWS

1.	Boxster Green tint window 1307mm x 609mm, 1.00mm thick	£42.21	sheet	D
2.	911/944/968 clear window 1730mm x 737mm, 1.00mm thick	£53.03	sheet	G
3.	Bronze window 1570mm x 736mm, 1.00mm thick	£47.78	sheet	F

THREADS

1.	Sewing thread, machine, Nr20 = 600m	£18.38	spool
2.	Sewing thread, machine, Nr30 = 900m	£18.38	spool
3.	Sewing thread, machine, Nr25 = 2000m resant	£33.60	spool
4.	Sewing thread, hand		

SUNDRIES

1.	Millboard	£10.82	sheet
2.	Calico	£6.51	metre
3.	Hessian 72 inch wide	£5.99	metre
4.	Hardura	£22.05	metre
5.	Black vinyl spray	£20.69	per can
6.	Vinyl prep small screw cap can	£8.19	each
7.	Blue foam 6 mm	£6.51	per sq metre
8.	Blue foam 12mm	£11.97	per sq metre
9.	Blue 12mm made to scrim ready to use to, EG seat centres	£20.58	per sq metre
10.	Hog rings per stick (approx. 60 per stick)	£2.63	per stick

ORIGINAL MATERIALS AND CODES

	Leather Colour	Code	Remarks
1.	Black	YDX 000 000 00 1AJ	1984 to 1990
2.	Black	YDS 000 000 00 8YR	From 1991
3.	Schiefer Grey	YDX 000 000 00 2WT	1989 - 1990
4.	Grau (Grey) Green	YDX 000 000 00 5JX	1985 - 1989
5.	Marine Blue	YDS 000 000 00 7JX	1987 - 1990
6.	Midnight Blue	YDS 000 000 00 H24	1995 -
7.	Maritime Blue	YDS 000 000 00 G55	1992 only
8.	Classic Grey	YDS 000 000 00 6XL	1991 - 1996
9.	Marmograu (Marble Grey)	YDS 000 000 00 3QN	1995 -
10.	Licht Grau (Light Grey)	YDS 000 000 00 8ZL	1991 - 1994
11.	Savanah Beige	YDS 000 000 00 S30	1997 -
12.	Kastanien (Chesnut) Braun	YDS 000 000 00 T15	1994 -
13.	Linen	YDX 000 000 00 7VX	1987 - 1990
14.	Pearl White	EHX 000 000 00 8YD	1983 - 1987
15.	Burgundy (Wine Red)	YDX 000 000 00 7LD	1983 - 1990
16.	Magenta	YDS 000 000 00 6YL	1991 - 1994
17.	Boxster Red	YDS 000 000 00 M30	1997 -
18.	Flamenco Red	YDS 000 000 00 8SE	1994 - 1996
19.	Matador Red	YDS 000 000 00 MO5	1991 - 1994
20.	Lipstick Red (Plum)	YDX 000 000 00 1MC	1987 only
21.	Can-Can Red	YDX 000 000 00 8OS	1981 - 1987
22.	Cedar Green	YDS 000 000 00 KO3	1994 - 1996
23.	Nephrite Green	YDS 000 000 00 J30	1997 -
24.	Ferrari Geld (Speed Yellow)		
25.	Graffitigrau (Graphite Grey)	YDS 000 000 00 C50	1998 -
26.	Space Grey	YDS 000 000 00 B50	1998 -
27.	Metropol Blue	YDS 000 000 00 G10	1998 -
28.	Dark Grey Natural		
29.	Brown Natural		
30.	Zimtbraun (Cinnamon)		
31.	Kashmir Beige	YDS 000 000 00 4YU	1991 - 1997
32.	Cobalt Blue	YDS 000 000 00 9YL	1991 - 1994
33.	Sherwood Green	YDS 000 000 00 J25	1991 - 1994
34.	Carrera Grey	YDS 000 000 00 D35	1991 - 1994
35.	Wimbledon Green	YDS 000 000 00 J17	1992 - 1993
36.	Grey Beige	EHX 000 000 00 6FL	1983 - 1986
37.	Blue	EHX 000 000 00 3OB	To 1987
38.	Brown	EHS 000 000 00 3NG	1979 to 1982
39.	Provence Blue	YDS 000 000 00 G43	1995 - 1996
40.	Rubicon Grey	YDS 000 000 00 E38	1994 only
41.	Palm Green		
42.	Steingrua (Stone Grey)		
43.	Stahlgrau (Steel Grey)		
44.	Havanna		
45.	Sand Beige		
46.	Silk Grey	000 000 00 5VT	1989-90

Minimum order from stock is ½ Hide. If we do not have available colours in stock, the minimum order is for 5 Hides from OEM manufacturer.

	Fabric Colour	Code
1	Berber, Grau/Schwarz (Grey/Black)	TPE 000 000 00 67B
2	Berber, Grau/Beige (Grey/Beige)	TPB 000 000 00 1FB

PLEASE NOTE ALL PRICES ARE UNDER REVIEW FOR 2023 AND MAY NOT BE AS PRINTED BELOW

3	Flanellstreifen (Flannel Pinstripe), Burgundy	TPC 000 000 00 1MF
4	Flanellstreifen (Flannel Pinstripe), Grau-Turkis (grey-Turquoise)	TPD 000 000 00 8JJ
5	Flanellstreifen (Flannel Pinstripe), Grau-Ockergelb	TPD 000 000 00 9VJ
6	Flanellstreifen (Flannel Pinstripe), Grau-Weinrot	TPD 000 000 00 6LJ
7	Flanellstreifen (Flannel Pinstripe), Brown 1975 - 1982	TPC 000 000 00 2TF
8	Schottenkaro Rot/Blau (Tartan Red/Blue) 1977 - 1982	999 551 081 40 8AB
9	Schottenkaro Grun/Blau (Tartan Green/Blue) 1977 - 1982	999 551 081 40 2AC
10	Schottenkaro Braun/Beige (Tartan Brown/Beige) 1977 - 1982	999 551 081 40 4AD
11	Tweed	999 551 034 40 3OO
12	Uni Stoff Blue	TPU 000 000 00 30C
13	Nadel Streifen (Pin Stripe) Velour, Burgundy	TPB 000 000 00 1MJ
14	Nadel Streifen (Pin Stripe) Velour, Grau/Grun	TPC 000 000 00 3JV
15	Nadel Streifen (Pin Stripe) Velour, Brown	TPB 000 000 00 3NN
16	Schachbrett (Pasha) Velour, Black/Grey	TPB 000 000 00 4FB
17	Schachbrett (Pasha) Velour, Braun (Brown)	TPB 000 000 00 5RH
18	Schachbrett (Pasha) Velour, Blau/Grau (Blue/Grey)	TPB 000 000 00 7GH
19	Porsche Script, Light Grey-Beige 1985 - 1989	TPC 000 000 00 8BY
20	Porsche Script, Braun (Brown) 1985 - 1989	TPC 000 000 00 7NZ
21	Porsche Script, Grau-Beige (Grey-Beige) 1985 - 1989	TPC 000 000 00 5UY
22	Porsche Script, Weinrot (Burgundy) 1985 -1990	TPC 000 000 00 5LZ
23	Porsche Script, Grau-Grun (Grey-Green) 1985 - 1989	TPC 000 000 00 1JK
24	Porsche Script, Leinen (Linen) 1989 - 1991	TPC 000 000 00 5WZ
25	Porsche Script, Kaschmir (Cashmere) 1989 -	TPC 000 000 00 7TH
26	Porsche Script, Magenta 1991 - 1995	TPC 000 000 00 9YC
27	Porsche Script, Cobalt Blau 1991 - 1995	TPC 000 000 00 7ZK
28	Porsche Script, Black 1985 - 1998	TPC 000 000 00 2CZ
29	Porsche Script, Light Grey 1991 - 1995	TPC 000 000 00 2ZV
30	Porsche Script, Grey, Red Script	Unknown
31	Cordstoff (Sport Cloth RS Buckets), Black 1992 -	TPD 000 000 00 B80
32	Studio Check, Marine Blau	TPD 000 000 00 9JV
33	Studio Check, Silver Rose	TPD 000 000 00
34	Dunes, Savanna-Beige	TPH 000 000 00 S30
35	Corduroy, Black 1967 - 1974	999 551 032 40 700

	Kunstleder (Vinyl/Leatherette, Seating & Panels) Colour	Code
1	Blue	BPX 000 000 00 1HH
2	Burgundy	BPX 000 000 00 3MK
3	Klassik Grau (Classic Grey)	BPX 000 000 00 5WH
4	Nacht Blau (Midnight Blue)	BPX 000 000 00 5HE
5	Marine Blau	BPX 000 000 00 1KX
6	Marmograu (Marble Grey)	BPX 000 000 00 7EB
7	Cobalt Blau	BPX 000 000 00 5ZF
8	Schwarz (Black)	BPX 000 000 00 43S
9	Kastanien Braun (Chestnut Brown)	BPX 000 000 00 6PC
10	Magenta	BPX 000 000 00 9WX
11	Lichtgrau (Light Grey)	BPX 000 000 00 3ZT
12	Kaschmir Beige (Cashmere Beige)	BPX 000 000 00 7RT
13	Savanna Beige – Boxster	BSK 000 000 00 S30
14	Brown Vinyl – Not OE, up to 1982 (911 SC)	
15	Black – 911 SC Type, up to 1982	
16	Grey Beige	BPX 000 000 00 4FK
17	Grey Green	4JX
18	Linen, 1987	4WX
19	Black (Early Smooth 644)	999 551 002 40 708
20	Light Grey (Beige)	BPX 000 000 00 2DX
21	Marine Blue	1KX

	Himmel (Headliner), as seating vinyl for ID purposes, colour	Code
1	Grey Beige Perforated	4FK
2	Chestnut Brown Plain	6PC

PLEASE NOTE ALL PRICES ARE UNDER REVIEW FOR 2023 AND MAY NOT BE AS PRINTED BELOW

3	Chestnut Brown Perforated	6PC
4	Classic Grey Plain	5WH
5	Classic Grey Perforated	5WH
6	Magenta Perforated	9WX
7	Wine Red (Burgundy) Perforated	
8	Black Plain 993	
9	Ivory (Not OEM)	
10	Marine Blue Perforated	
11	Kobalt Blue Perforated	
12	Night Blue Plain 993	
13	Targa Cloth Headliner Black	
14	Cabriolet Mohair Headliner Black	

	Carpet Colour	
1	Black 1976 – 1989	70E
2	Black 1989 – 1998	5VF
3	Marine Blue 1987 – 1988	3KF
4	Marine Blue 1989 – 1994	4KV
5	Night Blue 1994 – 1998	3GE
6	Cobalt Blue 1991 – 1994	4ZN
7	Provence Blue 1994 – 1996	1HQ
8	Rubicon Grey 1994	8AS
9	Classic Grey 1991 – 1998	4XR
10	Schiefer Grey 1989 – 1990	3WT
11	Matador Red 1991 – 1994	M33
12	Boxster Red (993) 1997 – 1998	TLV M30
13	Boxster Red (996/986) 1997 and on	TTA M30
14	Space Grey (996/986) 1997 and on	TTA B50
15	Graffiti Grey (996/986) 1997 and on	TTA C50
16	Black (996/986) 1997 and on	TTA A10
17	Dark Grey, Natural	TTA
18	Metropol Blue (996/986) 1997 and on	TTA G10
19	Boucle Anthraxit 356 911/912	
20	Perlon, Black RS 1972	
21	Perlon, Grey 911/912 (also boot)	000 551 572 00 700
22	Velour (Salt & Pepper) 1967 – 1974	000 551 570 00 700
23	Boucle Beige 356 911/912 till 1967	
24	Light Grey (Silver) 1991 – 1994	6YR
25	Magenta 1991 – 1994	8WZ
26	Burgundy 1982 – 1988	80E
27	Burgundy, Metallic 1989 – 1990	8MD
28	Chestnut Brown 1994 – 1997	6SC
29	Velvet Red 1989	9MT
30	Flamenco Red 1995 – 1997	3TE
31	Lipstick Red 1987 – 1989	4MM
32	Can Can Red 1983 – 1986	8OS
33	Brown 1979 – 1986	40E
34	Mahogany 1987 – 1989	5MF
35	Caramel 1987 – 1989	5UM
36	Cashmere Beige 1989 – 1998	8UT
37	Savanna Beige 1997 and on	TTA S30
38	Champagne 1983 – 1988	1VD
39	Cork 1976 – 1980	4ID
40	Grey Beige 1983 – 1986	2FL
41	Light Grey (Beige) 1983 – 1986	6OA
42	Linen 1987 – 1990	2XF
43	Silk 1989 – 1990	7VT
44	Marble Grey (Florentine Grey) 1992 – 1996	D50
45	Carrera Grey 1991 – 1994	D13
46	Grey Green 1985 – 1989	8JK

PLEASE NOTE ALL PRICES ARE UNDER REVIEW FOR 2023 AND MAY NOT BE AS PRINTED BELOW

47	Venetian Blue 1987 – 1990	3KM
48	Nephrite Green 1997 – 1998 (993)	TLV J30
49	Nephrite Green (996/986) 1997 and on	TTA J30
50	Wimbledon Green 1992 – 1994	K20
51	Green 1979 – 1982	20S
52	Sherwood Green 1991 – 1994	J23
53	Cedar Green 1994 – 1997	2JP